



TIRADORES
PUXADORES



9.1 Aluminio

Tiradores aluminio

9.02 Valencia, Munich, Atlanta, Niza, Bonn, Dallas, Liverpool, Almeria, Chicago, Glasgow, Breda, Dublin, Bilbao, Tulip1, Tulip 2, Monaco, Detroit, Madrid, Trento, Mahon, Tokio, Denver, Verona.

9.1 Alumínio

Puxadores alumínio

9.02 Valencia, Munich, Atlanta, Niza, Bonn, Dallas, Liverpool, Almeria, Chicago, Glasgow, Breda, Dublin, Bilbao, Tulip1, Tulip 2, Monaco, Detroit, Madrid, Trento, Mahon, Tokio, Denver, Verona.

9.2 Acero

Tiradores acero

9.09 Orlando, Seul, Porto, Coimbra.

9.2 Aço

Puxadores aço

9.09 Orlando, Seul, Porto, Coimbra.

9.3 Zamak

Tiradores zamak

9.12 Riga, Fuji, Habana, Praga, Tenerife, Hollywood, Dakar, Calgary, Minneapolis, Boston, Lanzarote, Toronto, Colorado, Jakarta, Shanghai, Lyon, Dubai, Zurich, Milano, Oslo, Manchester, Houston, Montevideo, Santiago, Acapulco, Ankara, Viena, Nimes, Reno, Oregon, Nairobi, Cairo, Haiti, Rabat, Papua, Marraquesh, Rabat, Mali, Kigali.

9.3 Zamak

Puxadores zamak

9.12 Riga, Fuji, Habana, Praga, Tenerife, Hollywood, Dakar, Calgary, Minneapolis, Boston, Lanzarote, Toronto, Colorado, Jakarta, Shanghai, Lyon, Dubai, Zurich, Milano, Oslo, Manchester, Houston, Montevideo, Santiago, Acapulco, Ankara, Viena, Nimes, Reno, Oregon, Nairobi, Cairo, Haiti, Rabat, Papua, Marraquesh, Rabat, Mali, Kigali.

9.4 ABS - PVC

Tiradores ABS - PVC

9.22 Como, Pisa, Ancona, Bari, Salo, Ferrara, Marino, Udine, Pompei, Riva, Imola, Sora, Tivoli.

9.4 ABS - PVC

Puxadores ABS - PVC

9.22 Como, Pisa, Ancona, Bari, Salo, Ferrara, Marino, Udine, Pompei, Riva, Imola, Sora, Tivoli.



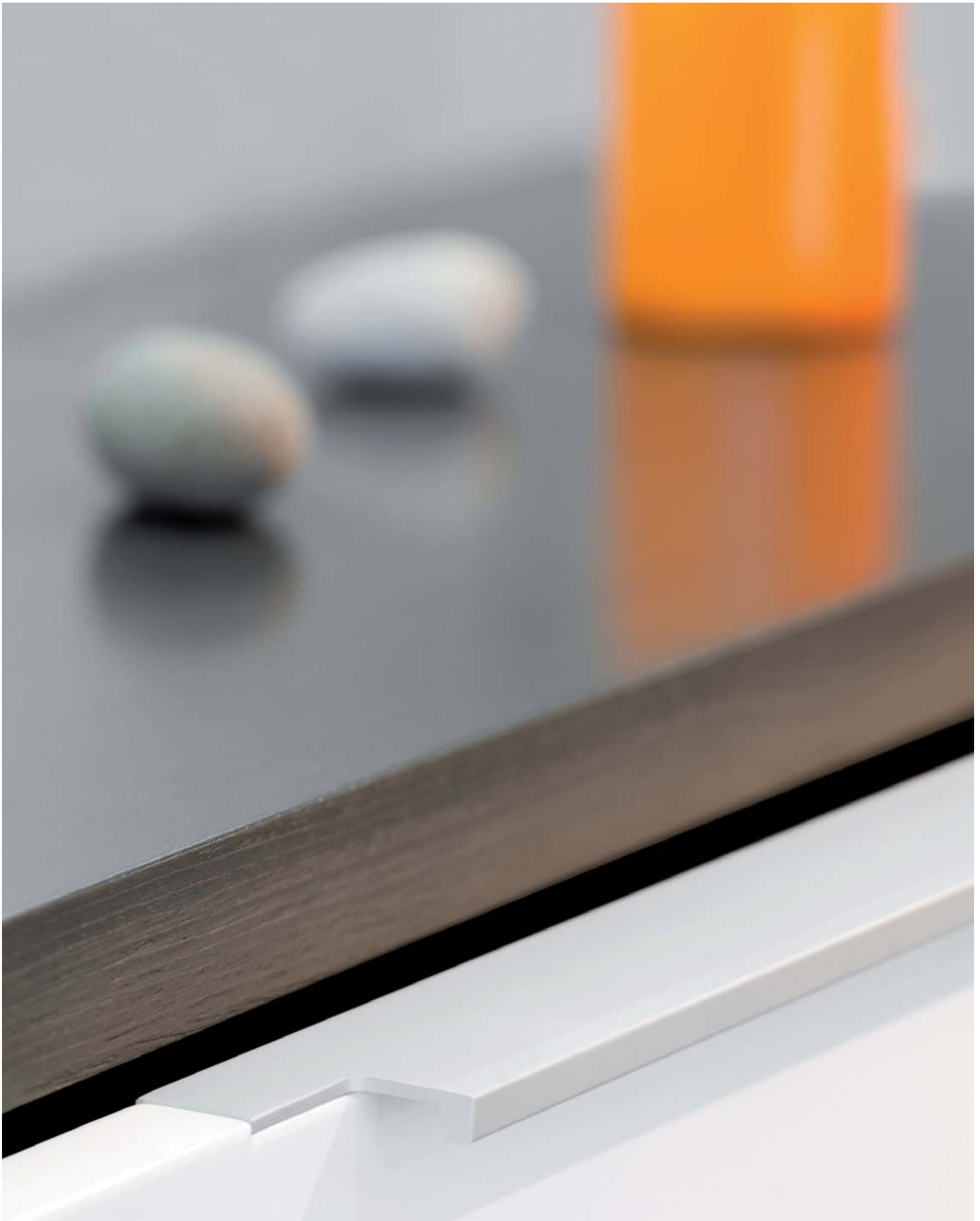

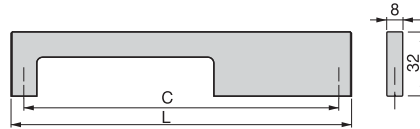

ALUMINIO
ALUMÍNIO

Valencia





| L | C | Cod.  |  |
|-----|-----|--|---|
| 172 | 160 | 99867 | 11 20 |
| 236 | 224 | 99868 | 11 20 |
| 524 | 512 | 99871 | 11 15 |

Aluminio / Aluminio

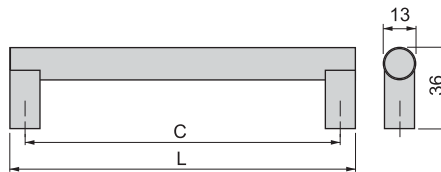
Munich





| L | C | Cod.  |  |
|-----|-----|--|---|
| 141 | 128 | 93209 | 62 15 |

Aluminio / Aluminio

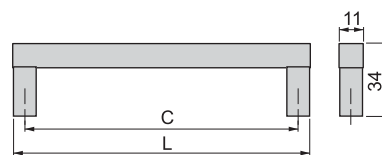
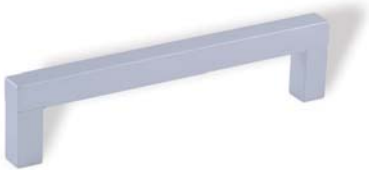
Atlanta



| L | C | Cod.  |  |
|-----|-----|--|---|
| 108 | 96 | 93196 | 62 15 |
| 140 | 128 | 93197 | 62 15 |
| 172 | 160 | 93198 | 62 15 |
| 268 | 256 | 93199 | 62 15 |
| 396 | 384 | 93200 | 62 15 |
| 492 | 480 | 93201 | 62 15 |
| 684 | 672 | 93203 | 62 15 |

Aluminio / Aluminio

Niza

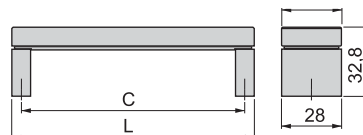

| L | C | Cod.  |  |
|-----|-----|--|---|
| 232 | 224 | 99864 | 11 8 |

Aluminio / Aluminio

Bonn

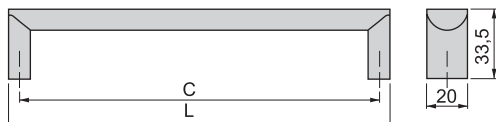

| L | C | Cod. | 62 | 10 |
|-----|-----|--------------|----|----|
| 138 | 128 | 93205 | 62 | 10 |
| 170 | 160 | 93206 | 62 | 10 |
| 234 | 224 | 93207 | 62 | 10 |
| 298 | 288 | 93208 | 62 | 10 |

Aluminio / Alumínio

Dallas

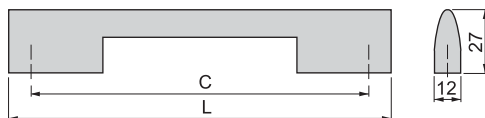

| L | C | Cod. | 62 | 20 |
|-----|-----|--------------|----|----|
| 176 | 160 | 93248 | 62 | 20 |
| 272 | 256 | 93249 | 62 | 20 |
| 400 | 384 | 93250 | 62 | 20 |

Aluminio / Alumínio

Liverpool

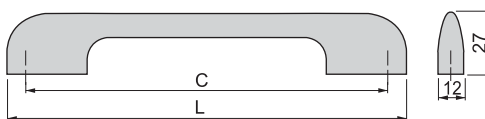

| L | C | Cod. | 11 | 62 | 20 |
|-----|-----|--------------|----|----|----|
| 176 | 160 | 93257 | 11 | 62 | 20 |
| 272 | 256 | 93258 | 11 | 62 | 20 |

Aluminio / Alumínio

Almeria

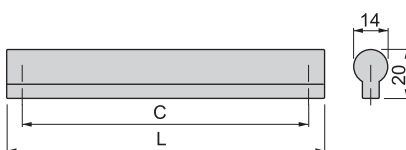



| L | C | Cod. | 62 | 25 |
|-----|-----|--------------|----|----|
| 52 | 32 | 93038 | 62 | 25 |
| 84 | 64 | 93039 | 62 | 25 |
| 148 | 128 | 93040 | 62 | 25 |

Aluminio / Alumínio

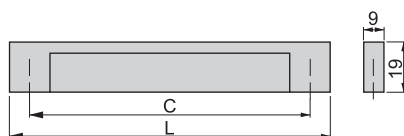

Chicago





| L | C | Cod. |  |  |
|-----|-----|--------------|---|---|
| 138 | 128 | 93221 | 60 | 25 |

Aluminio / Aluminio

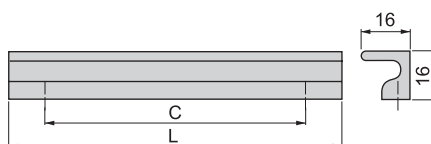
Glasgow



| L | C | Cod. |  |  |
|-----|-----|--------------|---|---|
| 52 | 32 | 93034 | 62 | 25 |
| 84 | 64 | 93035 | 62 | 25 |
| 148 | 128 | 93036 | 62 | 25 |
| 180 | 160 | 93037 | 62 | 25 |

Aluminio / Aluminio

Breda

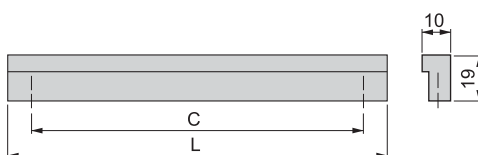



| L | C | Cod. |  |  |
|-----|----|--------------|---|---|
| 106 | 96 | 93542 | 62 | 30 |

Aluminio / Aluminio

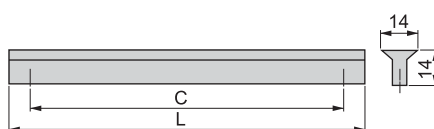
Dublin



| L | C | Cod. |  |  |
|-----|-----|--------------|---|---|
| 52 | 32 | 93030 | 62 | 25 |
| 84 | 64 | 93031 | 62 | 25 |
| 148 | 128 | 93032 | 62 | 25 |
| 180 | 160 | 93033 | 62 | 25 |

Aluminio / Aluminio

Bilbao

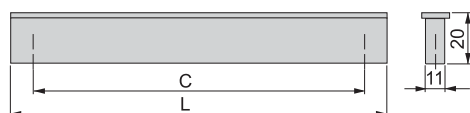

| L | C | Cod. | | | |
|-----|-----|--------------|----|----|----|
| 36 | 16 | 93298 | - | 62 | 50 |
| 52 | 32 | 91066 | 11 | - | 40 |
| 84 | 64 | 93300 | 11 | 62 | 30 |
| 148 | 128 | 93301 | 11 | 62 | 20 |
| 180 | 160 | 93302 | - | 62 | 20 |

Aluminio / Aluminio

Tulip 1

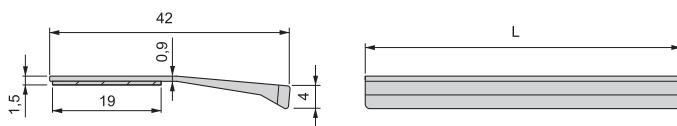

| L | Cod. | | | |
|-----|--------------|----|----|----|
| 62 | 69202 | - | 62 | 20 |
| 94 | 69203 | 60 | 62 | 20 |
| 126 | 69204 | - | 62 | 20 |
| 158 | 69205 | 60 | 62 | 20 |

Aluminio / Aluminio

Tulip 2

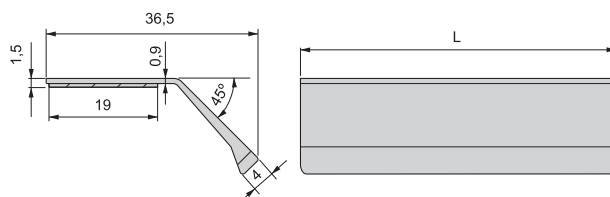

| L | Cod. | | | |
|-----|--------------|----|----|----|
| 62 | 69206 | - | 62 | 20 |
| 94 | 69207 | - | 62 | 20 |
| 126 | 69208 | - | 62 | 20 |
| 158 | 69209 | 60 | 62 | 20 |

Aluminio / Aluminio

Monaco

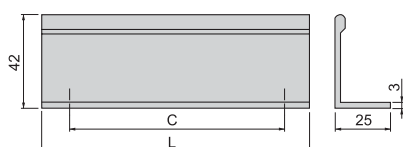
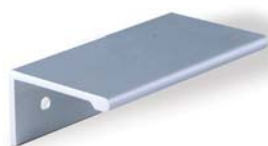



| L | C | Cod. | | |
|-----|-----|--------------|----|----|
| 78 | 50 | 93026 | 62 | 25 |
| 98 | 70 | 93027 | 62 | 25 |
| 148 | 100 | 93028 | 62 | 25 |

Aluminio / Aluminio

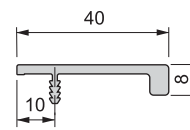
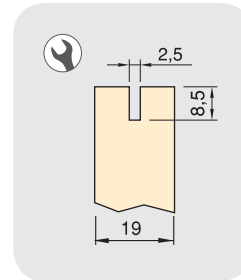

Detroit





| L | Cod.  |  |
|-----|--|---|
| 298 | 90042 | 62 25 |
| 398 | 90043 | 62 25 |
| 448 | 90044 | 62 25 |
| 498 | 90045 | 62 25 |
| 598 | 90046 | 62 25 |
| 698 | 90047 | 62 25 |
| 798 | 90062 | 62 25 |
| 898 | 90063 | 62 25 |

Aluminio / Aluminio

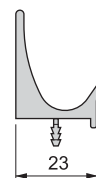
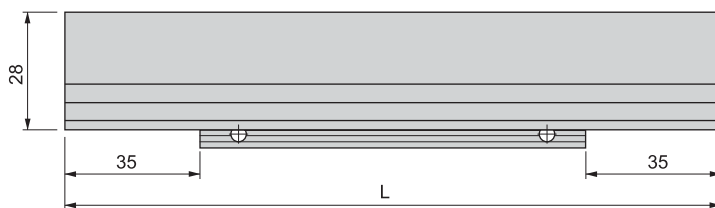
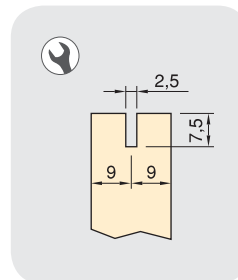
Madrid





| L | Cod.  |  |
|-----|--|---|
| 298 | 93113 | 62 10 |
| 398 | 93115 | 62 10 |
| 448 | 93116 | 62 10 |
| 498 | 93117 | 62 10 |
| 598 | 93118 | 62 10 |
| 698 | 93142 | 62 10 |
| 798 | 93143 | 62 10 |
| 898 | 93136 | 62 10 |
| 998 | 93144 | 62 6 |

Aluminio / Aluminio

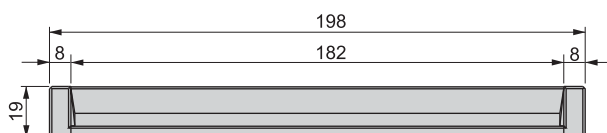
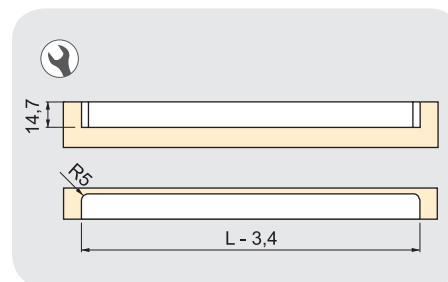
Trento



| L | Cod.  |  |
|-----|--|---|
| 80 | 89180 | 62 10 |
| 200 | 89167 | 62 10 |

Aluminio / Aluminio

Mahon

| L | C | Cod. | | |
|-----|-----|--------------|----|----|
| 191 | 160 | 90031 | 62 | 20 |

Aluminio / Aluminio

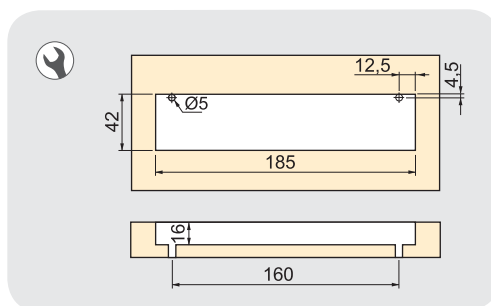
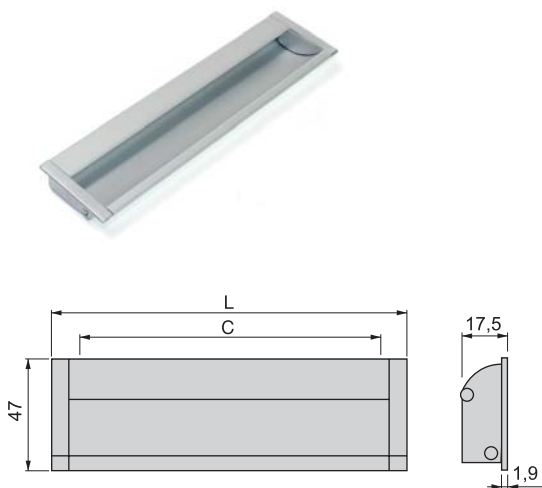

Tokio

| H | Ø | Cod. | | |
|----|----|--------------|----|----|
| 26 | 16 | 93321 | 62 | 50 |

Aluminio / Aluminio

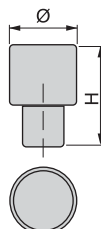

Denver

| H | Ø | Cod. | | |
|----|----|--------------|----|----|
| 20 | 12 | 93316 | 62 | 50 |
| 26 | 20 | 93318 | 62 | 50 |
| 22 | 16 | 93319 | 62 | 50 |

Aluminio / Aluminio

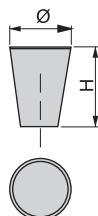

Verona

| H | Ø | Cod. | | |
|----|----|--------------|----|----|
| 25 | 25 | 93315 | 62 | 50 |

Aluminio / Aluminio

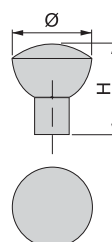

ACERO
AÇO

9.⁰⁸/₁₀



ACERO

AÇO

Orlando

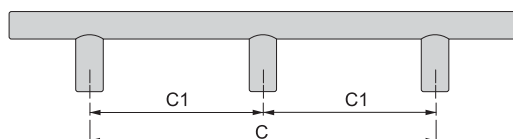
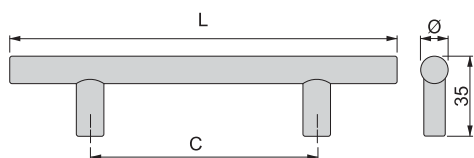



| Ø | L | C | C1 | Cod. | | |
|----|-------|-------|-----|--------------|----|----|
| 12 | 178 | 128 | - | 93526 | 51 | 10 |
| 12 | 188 | 128 | - | 92904 | 51 | 20 |
| 12 | 210 | 160 | - | 93527 | 51 | 10 |
| 12 | 252 | 192 | - | 92903 | 51 | 20 |
| 12 | 274 | 224 | - | 93528 | 51 | 10 |
| 12 | 306 | 256 | - | 93529 | 51 | 10 |
| 12 | 336 | 256 | - | 92902 | 51 | 10 |
| 12 | 380 | 320 | - | 93530 | 51 | 10 |
| 12 | 400 | 320 | - | 92901 | 51 | 10 |
| 12 | 423 | 356 | - | 93531 | 51 | 10 |
| 12 | 464 | 384 | - | 92900 | 51 | 10 |
| 12 | 526 | 456 | - | 93532 | 51 | 10 |
| 12 | 528 | 448 | - | 92925 | 51 | 10 |
| 12 | 592 | 512 | - | 92926 | 51 | 10 |
| 12 | 645 | 575 | - | 93533 | 51 | 10 |
| 12 | 720 | 640 | - | 92927 | 51 | 5 |
| 12 | 828 | 758 | 379 | 93534 | 51 | 5 |
| 12 | 848 | 768 | 384 | 92928 | 51 | 5 |
| 12 | 976 | 896 | 448 | 92929 | 51 | 5 |
| 12 | 1.104 | 1.024 | 512 | 92930 | 51 | 5 |
| 14 | 188 | 128 | - | 93088 | 51 | 20 |
| 14 | 252 | 192 | - | 93089 | 51 | 20 |
| 14 | 400 | 320 | - | 93091 | 51 | 10 |
| 14 | 528 | 448 | - | 93093 | 51 | 10 |
| 14 | 592 | 512 | - | 93094 | 51 | 10 |
| 14 | 976 | 896 | 448 | 93097 | 51 | 5 |

Acero / Aço

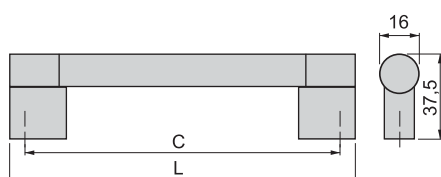

Seul





| L | C | Cod.  |  |
|-----|-----|--|---|
| 168 | 128 | 93081 | 51 20 |
| 232 | 192 | 93082 | 51 20 |
| 296 | 256 | 93083 | 51 10 |
| 360 | 320 | 93084 | 51 10 |
| 424 | 384 | 93085 | 51 10 |
| 488 | 448 | 93086 | 51 10 |
| 552 | 512 | 93087 | 51 10 |

Acero / Aço

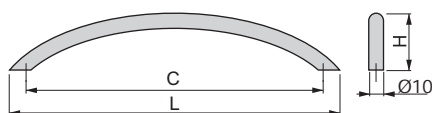
Porto





| H | L | C | Cod.  |  |
|----|-----|-----|--|---|
| 30 | 152 | 128 | 92978 | 51 25 |
| 32 | 190 | 160 | 92979 | 51 25 |
| 32 | 228 | 192 | 92980 | 51 20 |
| 32 | 263 | 224 | 92981 | 51 20 |
| 32 | 300 | 256 | 92982 | 51 20 |

Acero / Aço

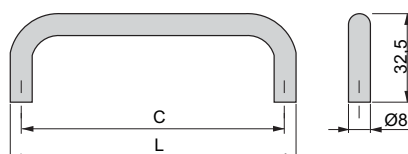
Coimbra



| L | C | Cod.  |  |
|-----|-----|--|---|
| 104 | 96 | 92988 | 11 20 |
| 136 | 128 | 92989 | 11 20 |

Acero / Aço



ZAMAK

ZAMAK

Riga

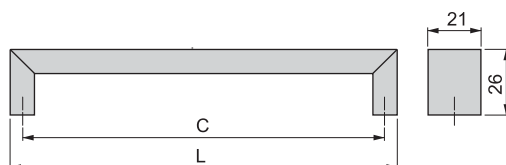



| L | C | Cod. |  |  |
|-----|-----|--------------|---|---|
| 138 | 128 | 93537 | 51 | 25 |

Zamak / Zamak

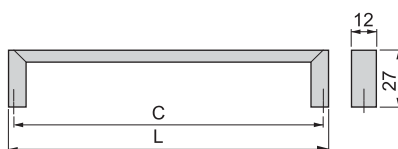
Fuji





| L | C | Cod. |  |  |
|-----|-----|--------------|---|---|
| 103 | 96 | 93539 | 25 | 51 |
| 135 | 128 | 93540 | 25 | 51 |

Zamak / Zamak

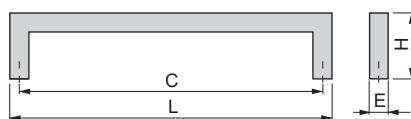
Habana





| E | H | L | C | Cod. |  |  |
|----|------|-----|-----|--------------|---|---|
| 9 | 30,8 | 136 | 128 | 92986 | 11 | 51 |
| 10 | 34,7 | 169 | 160 | 92987 | 11 | 51 |

Zamak / Zamak

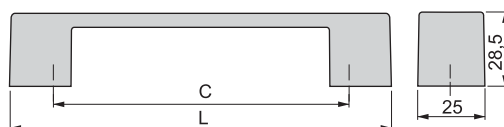
Praga



| L | C | Cod. |  |  |
|-----|-----|--------------|---|---|
| 162 | 128 | 92974 | 64 | 20 |
| 195 | 160 | 92975 | 64 | 20 |
| 228 | 192 | 92976 | 64 | 20 |

Zamak / Zamak

Tenerife

| L | C | Cod. | 11 | 25 | 25 |
|-----|-----|-------|----|----|----|
| 145 | 128 | 93152 | 11 | 25 | 25 |

Zamak / Zamak

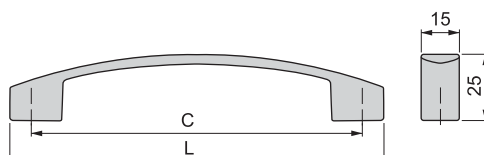

Hollywood

| L | C | Cod. | 51 | 25 |
|-----|-----|-------|----|----|
| 138 | 128 | 91548 | 51 | 25 |

Zamak / Zamak

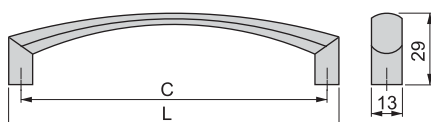

Dakar

| L | C | Cod. | 51 | 25 |
|-----|-----|-------|----|----|
| 198 | 128 | 91549 | 51 | 25 |

Zamak / Zamak

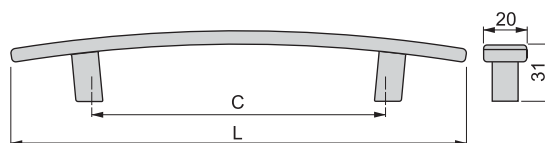

Calgary

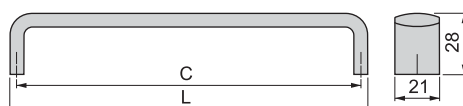

| L | C | Cod. | 51 | 64 | 25 |
|-----|-----|-------|----|----|----|
| 166 | 160 | 93163 | 51 | 64 | 25 |

Zamak / Zamak

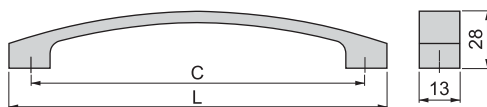

Minneapolis





| L | C | Cod. |  |  |
|-----|-----|--------------|---|---|
| 180 | 160 | 93155 | 51 | 64 |

Zamak / Zamak

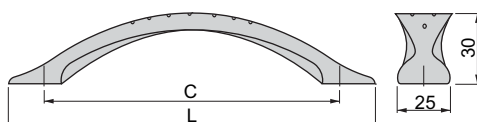
Boston



| L | C | Cod. |  |  |
|-----|-----|--------------|---|---|
| 170 | 128 | 93164 | 51 | 25 |

Zamak / Zamak

Lanzarote

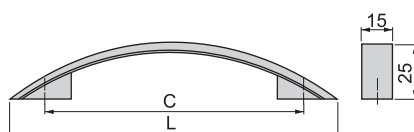



| L | C | Cod. |  |  |
|-----|-----|--------------|---|---|
| 165 | 128 | 61306 | 24 | 50 |

Zamak / Zamak

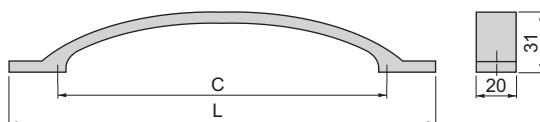

Toronto



| L | C | Cod. |  |  |
|-----|-----|--------------|---|---|
| 190 | 128 | 93166 | 51 | 64 |

Zamak / Zamak

Colorado

| L | C | Cod. |  |  |
|-----|-----|--------------|---|---|
| 160 | 128 | 92906 | 51 | 25 |

Zamak / Zamak

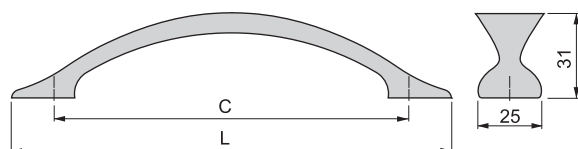



Jakarta

| L | C | Cod. |  |  |
|-----|-----|--------------|---|---|
| 155 | 128 | 61243 | 24 | 25 |

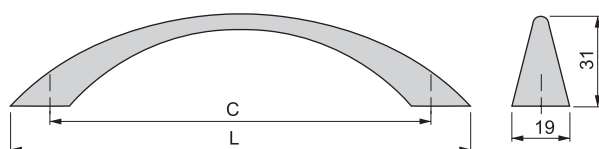
Zamak / Zamak



Shanghai

| L | C | Cod. |  |  |
|-----|-----|--------------|---|---|
| 190 | 128 | 93158 | 51 | 64 |

Zamak / Zamak

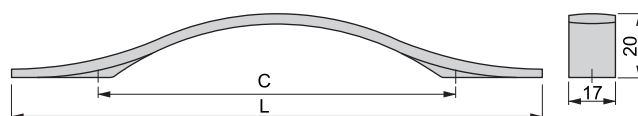



Lyon

| L | C | Cod. |  |  |
|-----|-----|--------------|---|---|
| 138 | 128 | 91556 | 51 | 25 |

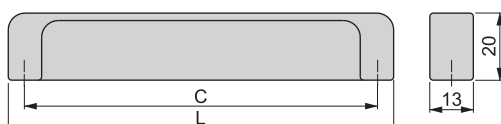
Zamak / Zamak





Dubai

| L | C | Cod. |  |  |
|-----|-----|--------------|---|---|
| 167 | 160 | 93547 | 64 | 25 |

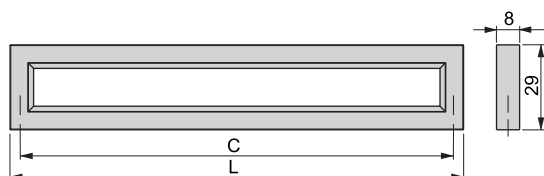
Zamak / Zamak



Zurich

| L | C | Cod. |  |  |
|-----|----|--------------|---|---|
| 159 | 96 | 93525 | 25 | 25 |

Zamak / Zamak

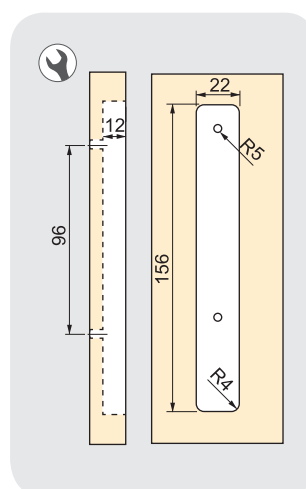
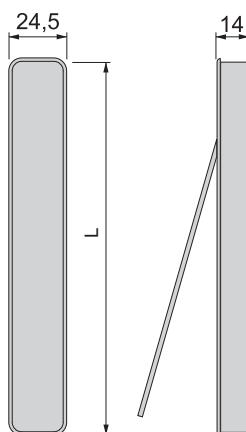



Milano

| Cod. |  |  |
|--------------|---|---|
| 93536 | 25 | 51 |

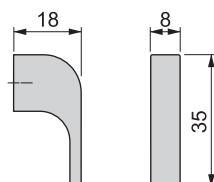
Zamak / Zamak



Oslo

| Cod. |  |  |
|--------------|---|---|
| 92994 | 51 | 100 |

Zamak / Zamak

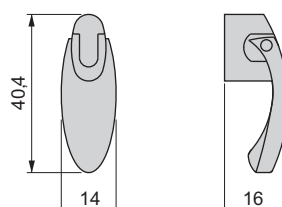

Manchester

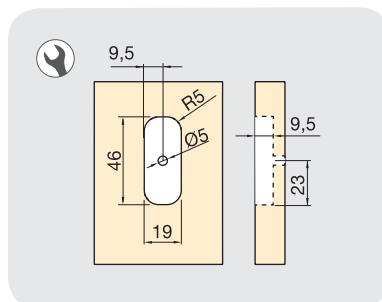
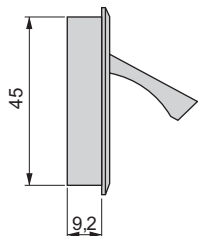
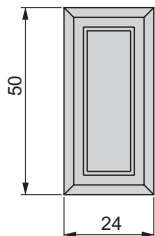

Cod.



| | | | |
|-------|----|----|-----|
| 93444 | 24 | 64 | 100 |
|-------|----|----|-----|

Zamak / Zamak

Houston

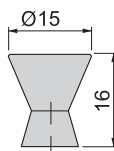

Cod.



| | | |
|-------|----|----|
| 92997 | 51 | 50 |
|-------|----|----|

Zamak / Zamak

Montevideo

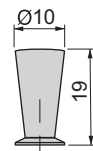

Cod.



| | | |
|-------|----|----|
| 93000 | 51 | 50 |
|-------|----|----|

Cobre / Copper

Santiago

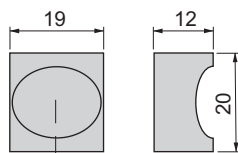

Cod.



| | | |
|-------|----|----|
| 92995 | 51 | 50 |
|-------|----|----|

Zamak / Zamak

Acapulco

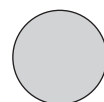
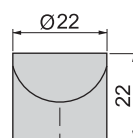

Cod.





| | | |
|-------|----|----|
| 91560 | 51 | 50 |
|-------|----|----|

Zamak / Zamak

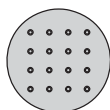
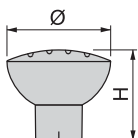

Ankara





| H | Ø | Cod. |  |  |
|----|----|--------------|---|---|
| 24 | 28 | 93170 | 51 | 25 |
| 27 | 33 | 93157 | 51 | 25 |

Zamak / Zamak

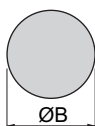
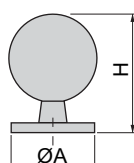
Viena



| H | ØA | ØB | Cod. |  |  |
|------|------|----|--------------|---|---|
| 27,1 | 18,4 | 20 | 92983 | 51 | 25 |
| 33,6 | 23,7 | 25 | 92984 | 51 | 25 |

Zamak / Zamak

Nimes

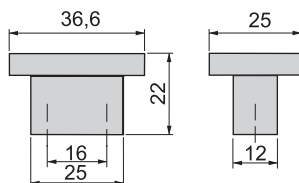

Cod. 

| | | |
|--------------|----|----|
| 92977 | 51 | 25 |
|--------------|----|----|

Zamak / Zamak

Reno

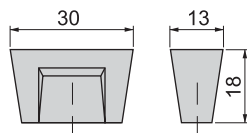

Cod. 

| | | |
|--------------|----|----|
| 93438 | 64 | 50 |
|--------------|----|----|

Zamak / Zamak

Oregon

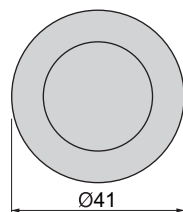
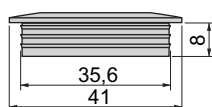

Cod. 

| | | |
|--------------|----|----|
| 92985 | 51 | 25 |
|--------------|----|----|

Zamak / Zamak

Nairobi

| L | C | Cod. | 08 | 20 |
|-----|----|--------------|----|----|
| 139 | 96 | 93493 | 08 | 20 |

Zamak / Zamak

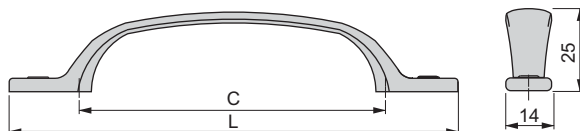

Cairo

| L | C | Cod. | 08 | 68 | 20 |
|-----|----|--------------|----|----|----|
| 110 | 96 | 93488 | 08 | 68 | 20 |

Zamak / Zamak

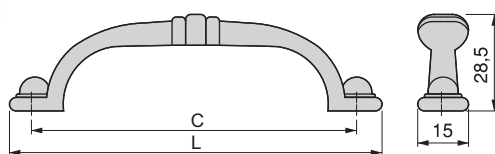

Haiti

| L | C | Cod. | 08 | 20 |
|-----|----|--------------|----|----|
| 125 | 76 | 93467 | 08 | 20 |

Zamak / Zamak

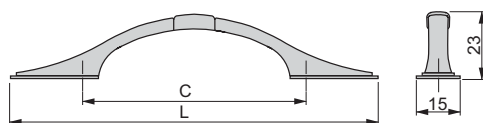

Rabat

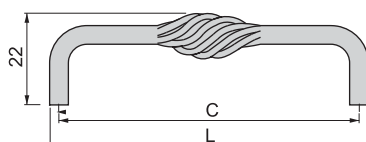

| L | C | Cod. | 68 | 25 |
|-----|-----|--------------|----|----|
| 104 | 96 | 93413 | 68 | 25 |
| 136 | 128 | 93414 | 68 | 25 |

Zamak / Zamak

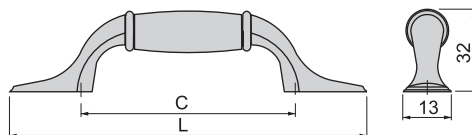

Papua





| L | C | Cod. |  |  |
|-----|----|--------------|---|---|
| 127 | 76 | 93491 | 08 | 68 |
| | | | | 20 |

Zamak / Zamak

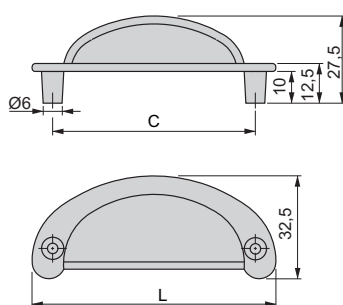
Marraqesh





| L | C | Cod. |  |  |
|----|----|--------------|---|---|
| 77 | 64 | 93489 | 08 | 20 |

Zamak / Zamak

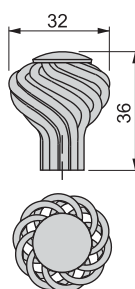
Rabat





| Cod. |  |  |
|--------------|---|---|
| 93427 | 68 | 10 |

Zamak / Zamak

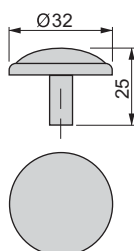
Mali



| Cod. |  |  |
|--------------|---|---|
| 93470 | 08 | 20 |

Zamak / Zamak

Kigali

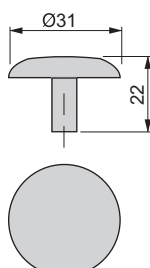

| Cod. |  |  |
|--------------|---|---|
| 93496 | 08 | 68 |
| | | 20 |

Zamak / Zamak

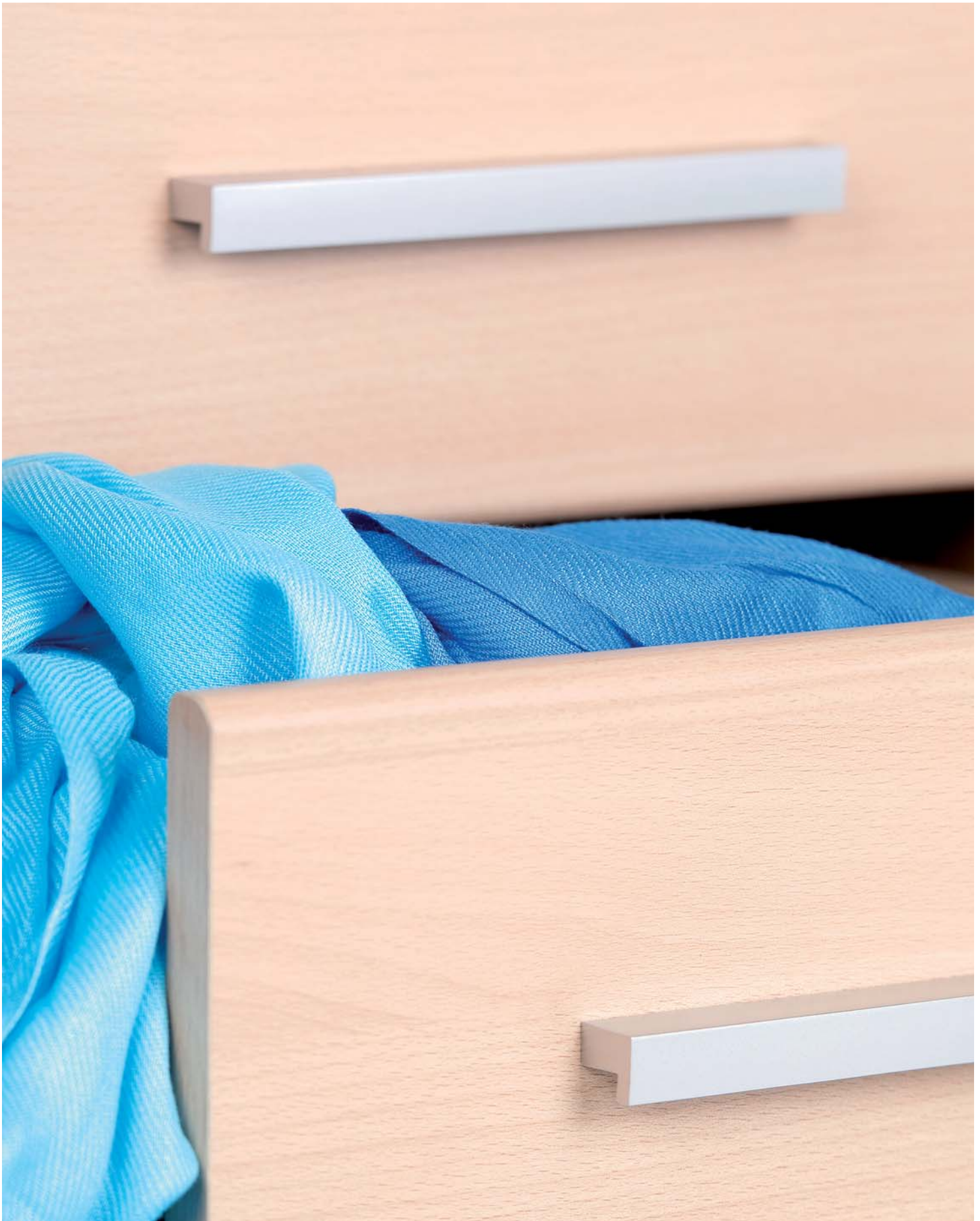



ABS - PVC

ABS - PVC

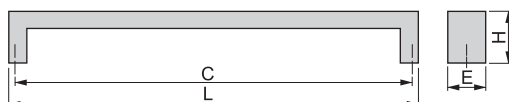
Como





| H | E | L | C | Cod. |  |  |
|----|----|-----|-----|--------------|---|---|
| 26 | 12 | 104 | 96 | 90059 | 25 | 25 |
| 33 | 14 | 138 | 128 | 90015 | 25 | 25 |

ABS

Pisa





| L | C | Cod. |  |  |
|-----|-----|--------------|---|---|
| 189 | 160 | 90022 | 25 | 25 |

ABS

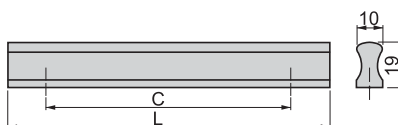
Ancona





| L | C | Cod. |  |  |
|-----|-----|--------------|---|---|
| 45 | 32 | 90004 | 25 | 25 |
| 80 | 64 | 90057 | 25 | 25 |
| 160 | 128 | 90007 | 25 | 25 |

PVC

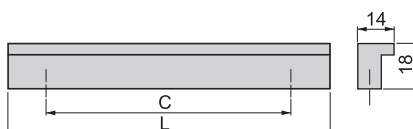
Bari



| L | C | Cod. |  |  |
|-----|-----|--------------|---|---|
| 80 | 64 | 90010 | 25 | 25 |
| 120 | 96 | 90011 | 25 | 25 |
| 160 | 128 | 90012 | 25 | 25 |
| 200 | 160 | 90058 | 25 | 25 |

PVC

Salo

| L | C | Cod. | 25 | 25 |
|-----|-----|-------|----|----|
| 230 | 160 | 90027 | 25 | 25 |

ABS

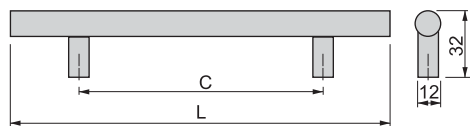

Ferrara

| L | C | Cod. | 25 | 25 |
|-----|-----|-------|----|----|
| 245 | 160 | 90016 | 25 | 25 |

ABS

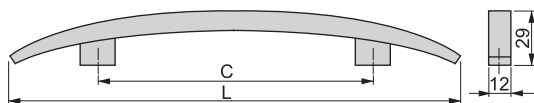

Marino

| L | C | Cod. | 25 | 25 |
|-----|-----|-------|----|----|
| 175 | 160 | 90020 | 25 | 25 |

ABS

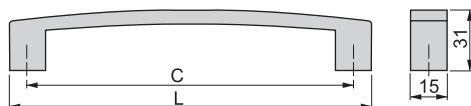



Udine

| L | C | Cod. | 25 | 25 |
|-----|-----|-------|----|----|
| 173 | 160 | 90019 | 25 | 25 |

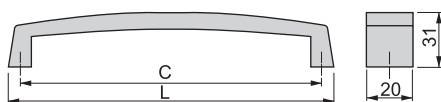
ABS





Pompei

| L | C | Cod.  |  |
|-----|-----|--|---|
| 199 | 160 | 90021 25 | 25 |

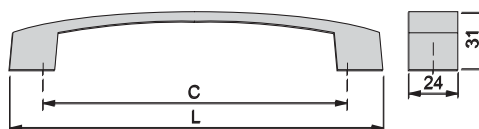
ABS





Riva

| L | C | Cod.  |  |
|-----|-----|--|---|
| 200 | 160 | 90023 25 | 25 |

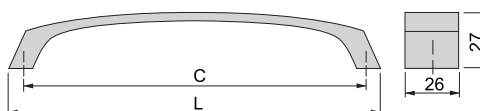
ABS



Imola

| L | C | Cod.  |  |
|-----|-----|--|---|
| 165 | 128 | 90017 25 | 25 |

ABS

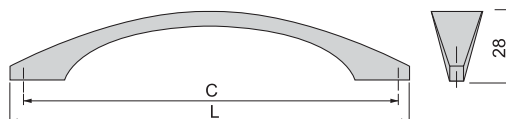

Sora

| Cod.  |  |
|--|---|
| 90028 25 | 50 |

ABS

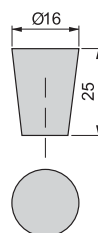

Tivoli

| Cod.  |  |
|--|---|
| 90029 25 | 50 |

ABS

